

Surface Mount Unidirectional and Bidirectional Transient Voltage Suppressors

Features

- Peak power dissipation 600W @10 x 1000 us Pulse
- Low profile package.
- Excellent clamping capability.
- Glass passivated junction.
- Fast response time: typically less than 1ps from 0 Volts to BV min
- Typical IR less than 1uA when VBR min above 12V.
- IEC 61000-4-2 ESD 30KV(Air), 30KV(Contact)
- ESD protection of data lines in accordance with IEC 61000-4-2
- EFT protection of data lines in accordance with IEC 61000-4-4
- Halogen free and RoHS compliant
- Lead-free finish

Mechanical Characteristics

- CASE: SMB (DO-214AA) Molded Plastic over glass passivated junction.
- Mounting Position: Any
- Polarity: by cathode band denotes uni-directional device, none cathode band denotes bi-directional device.
- Terminal: Solder plated

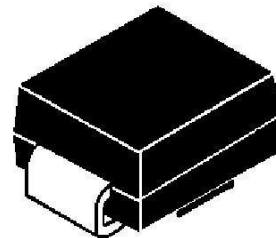

SMB

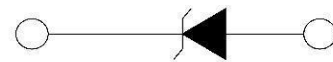

Uni-directional



Bi-directional

Ordering Information

Device	Qty per Reel	Reel Size
SMBJxxA(CA)	3000	13Inch

Absolute Maximum Ratings (TA=25°C unless otherwise specified)

Characteristics	Symbols	Value	Unit
Peak Power Dissipation At T _j = 25°C, T _p = 1ms (Note 1,2)	P _{PK}	600	W
Peak Forward Surge Current 8.3ms single half sine-wave super	I _{FSM}	100	A
Lead Soldering Temperature	T _L	260 (10 sec.)	°C
Operating Temperature Range	T _J	-55 to +155	°C
Storage Temperature Range	T _{STG}	-55 to +175	°C

Notes:

- Non-repetitive current pulse, per Fig.3 and derated above TA=25°C per Fig.2.
- Mounted on 5.0x5.0mm² (0.03mm thick) Copper Pads to each terminal.
- Measured on 8.3ms single half sine-wave, or equivalent square wave, for Unidirectional device only.

Electrical Characteristics (TA=25°C unless otherwise specified)

SMBJ PART NUMBER		MARKING CODE		V _{RWM}	V _{BR} @ I _T (V)		I _T	I _R @ V _{RWM}	V _C (Max)	I _{PP} (Max)
Uni-polar	Bi-polar	Uni	Bi	(V)	Min	Max	(mA)	(uA)	(V)	(A)
SMBJ5.0A	SMBJ5.0CA	KE	AE	5.0	6.38	7.35	10	800	9.2	65.3
SMBJ6.0A	SMBJ6.0CA	KG	AG	6.0	6.67	7.89	10	800	10.3	58.3
SMBJ6.5A	SMBJ6.5CA	KK	AK	6.5	7.22	8.30	10	500	11.2	53.6
SMBJ7.0A	SMBJ7.0CA	KM	AM	7.0	7.78	8.95	10	200	12.0	50.0
SMBJ7.5A	SMBJ7.5CA	KP	AP	7.5	8.33	9.58	1	100	12.9	46.5
SMBJ8.0A	SMBJ8.0CA	KR	AR	8.0	8.89	10.23	1	50	13.6	44.1
SMBJ8.5A	SMBJ8.5CA	KT	AT	8.5	9.44	10.82	1	20	14.4	41.7
SMBJ9.0A	SMBJ9.0CA	KV	AV	9.0	10.0	11.5	1	10	15.4	39.0
SMBJ10A	SMBJ10CA	KX	AX	10	11.1	12.8	1	5	17.0	35.3
SMBJ11A	SMBJ11CA	KZ	AZ	11	12.2	14.0	1	5	18.2	33.0
SMBJ12A	SMBJ12CA	LE	BE	12	13.3	15.3	1	5	19.9	30.2
SMBJ13A	SMBJ13CA	LG	BG	13	14.4	16.5	1	5	21.5	27.9
SMBJ14A	SMBJ14CA	LK	BK	14	15.6	17.9	1	5	23.2	25.9
SMBJ15A	SMBJ15CA	LM	BM	15	16.7	19.2	1	5	24.4	24.6
SMBJ16A	SMBJ16CA	LP	BP	16	17.8	20.5	1	5	26.0	23.1
SMBJ17A	SMBJ17CA	LR	BR	17	18.9	21.7	1	5	27.6	21.7
SMBJ18A	SMBJ18CA	LT	BT	18	20.0	23.3	1	5	29.2	20.5
SMBJ20A	SMBJ20CA	LV	BV	20	22.2	25.5	1	5	32.4	18.5
SMBJ22A	SMBJ22CA	LX	BX	22	24.4	28.0	1	5	35.5	16.9
SMBJ24A	SMBJ24CA	LZ	BZ	24	26.7	30.7	1	5	38.9	15.4
SMBJ26A	SMBJ26CA	ME	CE	26	28.9	33.2	1	5	42.1	14.3
SMBJ28A	SMBJ28CA	MG	CG	28	31.1	35.8	1	5	45.4	13.2
SMBJ30A	SMBJ30CA	MK	CK	30	33.3	38.3	1	5	48.4	12.4
SMBJ33A	SMBJ33CA	MM	CM	33	36.7	42.2	1	5	53.3	11.3
SMBJ36A	SMBJ36CA	MP	CP	36	40.0	46.0	1	5	58.1	10.3
SMBJ40A	SMBJ40CA	MR	CR	40	44.4	51.1	1	5	64.5	9.3
SMBJ43A	SMBJ43CA	MT	CT	43	47.8	54.9	1	5	69.4	8.6
SMBJ45A	SMBJ45CA	MV	CV	45	50.0	57.5	1	5	72.7	8.3
SMBJ48A	SMBJ48CA	MX	CX	48	53.3	61.3	1	5	77.4	7.8
SMBJ51A	SMBJ51CA	MZ	CZ	51	56.7	65.2	1	5	82.4	7.3
SMBJ54A	SMBJ54CA	NE	DE	54	60.0	69.0	1	5	87.1	6.9
SMBJ58A	SMBJ58CA	NG	DG	58	64.4	74.1	1	5	93.6	6.4
SMBJ60A	SMBJ60CA	NK	DK	60	66.7	76.7	1	5	96.8	6.2
SMBJ64A	SMBJ64CA	NM	DM	64	71.1	81.8	1	5	103	5.8
SMBJ70A	SMBJ70CA	NP	DP	70	77.8	89.5	1	5	113	5.3
SMBJ75A	SMBJ75CA	NR	DR	75	83.0	95.8	1	5	121	5.0
SMBJ78A	SMBJ78CA	NT	DT	78	86.0	99.7	1	5	126	4.8
SMBJ85A	SMBJ85CA	NV	DV	85	94.0	108.2	1	5	137	4.4
SMBJ90A	SMBJ90CA	NX	DX	90	100	115.5	1	5	146	4.1

SMBJ PART NUMBER		MARKING CODE		V_{RWM}	$V_{BR} @ I_T$ (V)		I_T	$I_R @ V_{RWM}$	$V_C(\text{Max})$	$I_{PP}(\text{Max})$
Uni-polar	Bi-polar	Uni	Bi	(V)	Min	Max	(mA)	(uA)	(V)	(A)
SMBJ100A	SMBJ100CA	NZ	DZ	100	111	128.0	1	5	162	3.7
SMBJ110A	SMBJ110CA	PE	EE	110	122	140.5	1	5	177	3.4
SMBJ120A	SMBJ120CA	PG	EG	120	133	153.0	1	5	193	3.1
SMBJ130A	SMBJ130CA	PK	EK	130	144	165.5	1	5	209	2.9
SMBJ150A	SMBJ150CA	PM	EM	150	167	192.5	1	5	243	2.5
SMBJ160A	SMBJ160CA	PP	EP	160	178	205.0	1	5	259	2.3
SMBJ170A	SMBJ170CA	PR	ER	170	189	217.5	1	5	275	2.2
SMBJ180A	SMBJ180CA	PT	ET	180	200	230.4	1	5	290	2.1
SMBJ190A	SMBJ190CA	PV	EV	190	211	243.2	1	5	306	2.0
SMBJ200A	SMBJ200CA	PX	EX	200	222	256.0	1	5	322	1.9
SMBJ210A	SMBJ210CA	PZ	EZ	210	233	268.8	1	5	339	1.8
SMBJ220A	SMBJ220CA	QE	FE	220	244	281.6	1	5	355	1.7
SMBJ250A	SMBJ250CA	QG	FG	250	278	309.0	1	5	403	1.5
SMBJ300A	SMBJ300CA	QK	FK	300	333	371.0	1	5	484	1.2
SMBJ350A	SMBJ350CA	QM	FM	350	389	432.0	1	5	565	1.1
SMBJ400A	SMBJ400CA	QP	FP	400	444	494.0	1	5	645	0.9
SMBJ440A	SMBJ440CA	QR	FR	440	489	543.0	1	5	710	0.8

I-V Curve Characteristics

Symbol	Parameter
V_{RWM}	Working Peak Reverse Voltage
V_{BR}	Breakdown Voltage @ I_T
V_C	Clamping Voltage @ I_{PP}
I_T	Test Current
I_R	Leakage current at V_{RWM}
I_{PP}	Peak pulse current

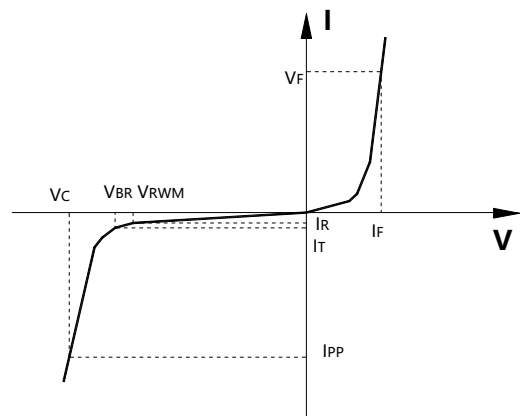

P_{PPM} Peak Pulse Power Dissipation – Max power dissipation

V_{RWM} Reverse Stand-off Voltage – Maximum voltage that can be applied to TVS without operation

V_{BR} Breakdown Voltage – Maximum voltage that flows though the TVS at a specified current (I_T)

V_C Clamping Voltage – Peak voltage measured across the TVS at a specified I_{PPM} (peak impulse current)

I_R Reverse Leakage Current – Current measured at V_R

V_F Forward Voltage – Drop for Uni-directional

Typical Performance Characteristics (T_A=25°C unless otherwise Specified)

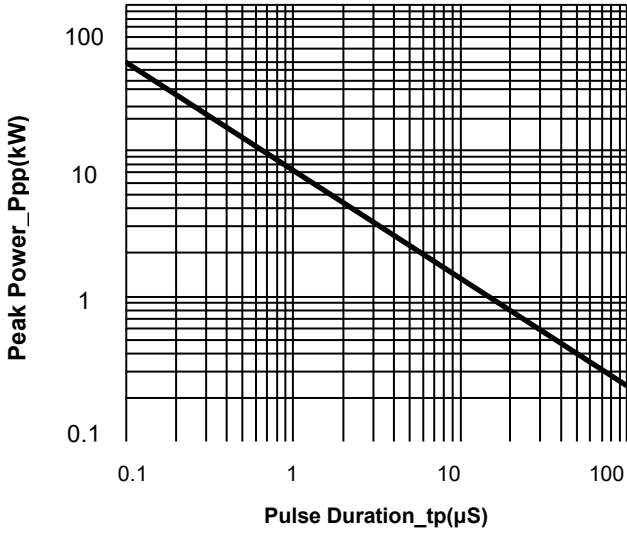

Peak Pulse Power vs. Pulse Time

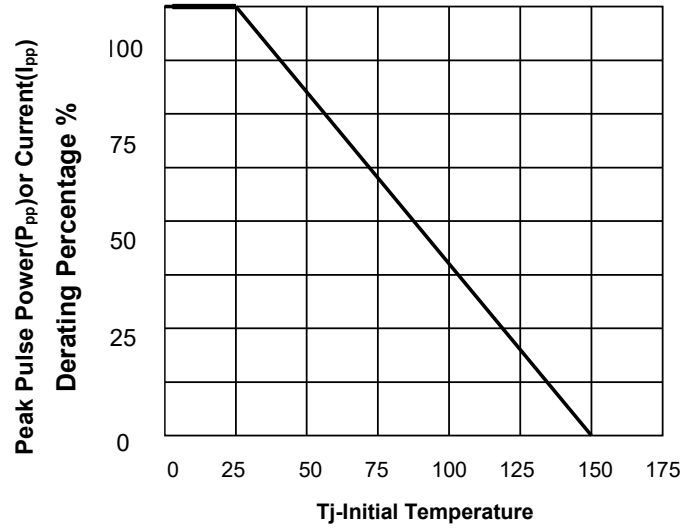

Fig.2 - Pulse Derating Curve

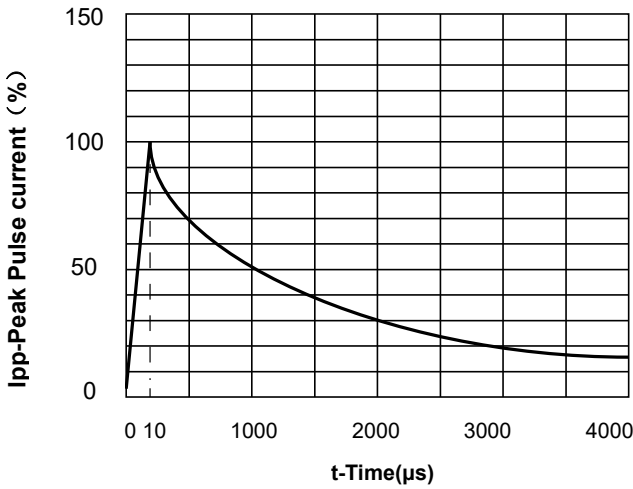

Fig.3 - Pulse Waveform

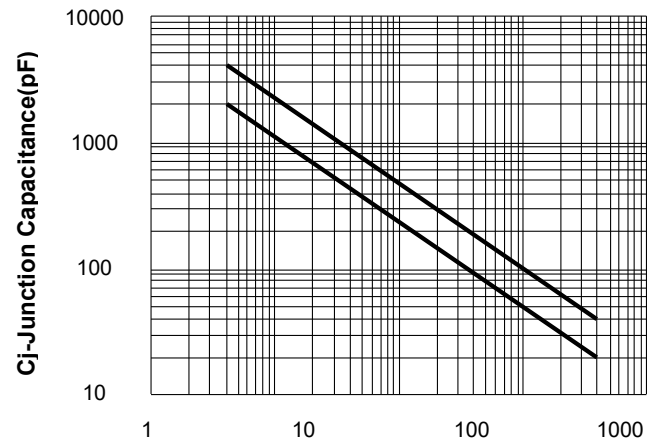
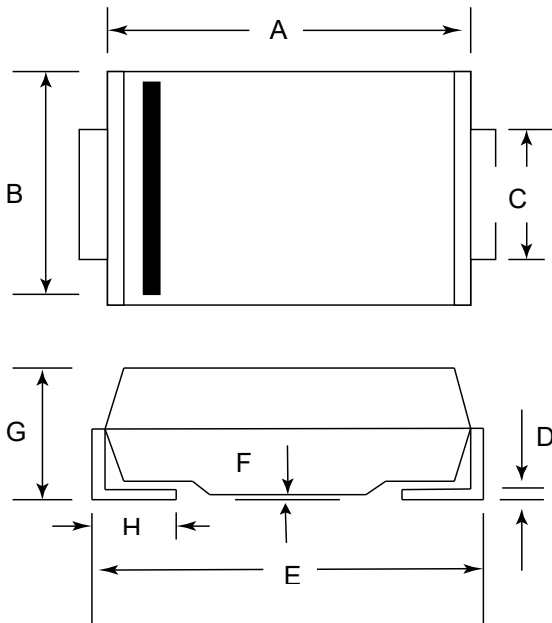

Fig.4 - Typical Junction Capacitance

Package Dimensions



Dim	Millimeters		Inches	
	Min	Max	Min	Max
A	4.06	4.57	0.160	0.180
B	3.30	3.94	0.130	0.155
C	1.78	2.20	0.070	0.086
D	0.13	0.31	0.006	0.012
E	5.08	5.59	0.200	0.220
F	----	0.20	----	0.008
G	1.95	2.62	0.077	0.103
H	0.76	1.52	0.030	0.060

Suggested Land Pattern

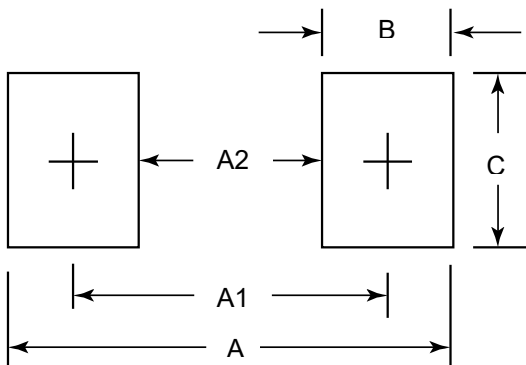

DIM	Millimeters
A	6.58
A1	4.42
A2	2.26
B	2.16
C	2.75